

Instructions for Use

Masimo iSirona™



Contents

Preface.....	4
Symbols.....	4
Intended audience.....	4
Compliance and safety information.....	5
Notices.....	7
Legal.....	7
Authorized representative.....	7
Contacts.....	8
Support contact information.....	8
Manufacturer contact.....	8
Chapter 1: About the Masimo iSirona.....	9
Included in the Masimo iSirona kit.....	9
Masimo iSirona diagrams.....	10
Masimo iSirona size and weight.....	12
Connectivity options.....	12
Power sources.....	13
Turn the Masimo iSirona on and off.....	13
Chapter 2: Install and remove the Masimo iSirona.....	14
Install the Masimo iSirona.....	14
Remove the Masimo iSirona from mounting bracket.....	14
Mounting bracket configurations.....	14
Chapter 3: Battery maintenance.....	15
Charge the battery.....	15
Replace the battery.....	15
Battery cautions.....	15
Chapter 4: View the Masimo iSirona status.....	17
Chapter 5: General handling instructions.....	19
Appendix A: Appendix.....	20
Electromagnetic emissions.....	20
Immunity Standards (Non-Life Support).....	20

Trademark attributions

These trademarks and all related logos and brandings are trademarks of Masimo Corporation. All other trademarked product names, brands, images, and other material are the property of their respective owners. Their use in this document does not imply a relationship between Masimo Corporation and the trademark holder.











- iSirona™
- DCX™
- Shuttle™
- Masimo®

Revision history

Date	Revision number	Description
January 5, 2021	1.0	Initial version
January 8, 2021	2.0	Note added: Masimo iSirona is compatible with DCX versions 05.16.000-0 and above.

Preface

Symbols

	Caution
	Manufacturer
	Authorized representative
	The CE mark indicates conformity with health, safety, and environmental protection standards for products sold within the European Economic Area
	Consult the user manual
	Separate collection for waste of electrical and electronic equipment
	The Nationally Recognized Testing Laboratory (NRTL) mark is the certification mark of a nationally recognized test lab as accredited by the Occupational Health and Safety Administration (OSHA).
	The Federal Communications Commission (FCC) mark is a certification mark on electronic products manufactured or sold in the United States that certifies that the electromagnetic interference from the device is under limits approved by the FCC.
	Temperature
	Humidity
	Atmospheric pressure

Intended audience

Masimo iSirona is a medical device integration (MDI) solution intended to be used in clinical settings including hospitals, medical centers, and clinics.

The intended users of iSirona include hospital technical personnel, including IT professionals and biomedical engineers, who install, maintain, and troubleshoot iSirona. Intended users also include hospital clinical personnel including nurses and nursing aids who clean iSirona and ensure that medical device data is flowing through iSirona to the EMR.

Compliance and safety information

The Masimo iSirona meets regulations for use in the United States, Canada, and Europe.

Federal Communications Commission (FCC)

The Masimo iSirona contains FCC ID VKF-IRISA1.

This device complies with part 15 of the Federal Communications Commission (FCC) rules and regulations delineated in Title 47 CFR, Part 15, Subpart B, Class B for unintentional radiators.

This equipment has been tested and found to comply with the limits for a Class B digital device, pursuant to Part 15 of the FCC Rules. These limits are designed to provide reasonable protection against harmful interference in a residential installation.

This equipment generates, uses, and can radiate radio frequency energy, and if not installed and used in accordance with the instructions, may cause harmful interference to radio communications. However, there is no guarantee that interference will not occur in a particular installation.

If this equipment does cause harmful interference to radio or television reception, which can be determined by turning the equipment off and on, the user is encouraged to try to correct the interference by one or more of the following measures:

- Increase the separation between the equipment and the receiver.
- Connect the equipment into an outlet on a circuit different from that to which the receiver is connected.
- Consult the dealer or an experienced radio/TV technician for help.

Any changes or modifications not expressly approved by the manufacturer could void the user's authority to operate the equipment.

This device is restricted to indoor use only when operating in the 5.15 GHz to 5.25 GHz frequency band (U-NII 1).

Canadian ISED Compliance

The Masimo iSirona complies with Canada's Interference-Causing Equipment Standards, ICES-003 Class B for unintentional radiators.

Conformité Européenne (CE)

The Masimo iSirona complies with the following CE directives:

- Electromagnetic Compatibility Directive, 2014/30/EU
- Restriction of Hazardous Substances Directive, 2011/65/EU
- Waste Electrical and Electronic Equipment Directive, 2012/19/EU
- LVD - The Low Voltage Directive, 2014/35/EU
- RED - the Radio Equipment Directive, 2014/53/EU

Dodd-Frank Consumer Protection Act

All components and materials in the iSirona conform to Section 1502 Dodd-Frank Consumer Protection Act (commonly referred to conflict minerals).











FCC radiation exposure statement

The equipment must be installed to provide a separation distance of at least 7.9 inches (20cm) from all persons during operation, and must not be co-located or operated in conjunction with any antenna or transmitter subject to the conditions of the FCC Grant.

Cautions



Only use the provided AC power cable to connect the power supply to a main power outlet that is properly installed and grounded, in accordance with all local codes and ordinances. If the power supply cord is damaged, contact Masimo for a replacement.

	Only use the Masimo-provided battery.
	Power over Ethernet is an available feature defined by IEEE 802.3 Type 1, Class 3.
	As a safety measure to prevent potential adverse results to data transmission, do not plug personal electronics into a iSirona USB port.
	Any and all configurations that use this device must be tested for electrical isolation before being used for patient care.
	Do not modify the device without authorization. Any modifications must be inspected and approved by Masimo.
	Use of this equipment adjacent to or stacked with other equipment should be avoided because it could result in improper operation or degraded performance.
	Use of accessories, transducers, and cables other than those specified or provided by the manufacturer of this equipment could result in increased electromagnetic emissions or decreased electromagnetic immunity of this equipment and result in improper operation.
	The use of ITE grade USB extenders or USB hubs is not recommended. Only the RS232 interface can be extended but not more than 15m.
	Portable RF communications equipment (including peripherals such as antenna cables and external antennas) should be used no closer than 30 cm (12 inches) to any part of the iSirona or its cables or any attached RS-232 extension cables. Otherwise, a degradation in the performance of this equipment could result.
	Do not immerse the Masimo iSirona in water or any other liquid.
	The iSirona should only be connected to IEC 60601-1 compliant devices.

Disposal and recycling information



The symbol on the Masimo iSirona indicates that this product must not be disposed of with your other unsorted waste. Instead, it is your responsibility to dispose of your waste equipment by handing it over to a designated collection point for the recycling of waste electrical and electronic equipment. The separate collection and recycling of your waste equipment at the time of disposal will help conserve natural resources and ensure that it is recycled in a manner that protects human health and the environment. For more information about where you can drop off your waste for recycling, please contact your local authority, or the manufacturer contact listed in the Indications for Use.

Notices

Legal

© 2020 Masimo Corp. and its affiliates. All rights reserved.

This document and the information presented herein are proprietary and confidential information of Masimo Corporation ("Masimo") and shall not, directly or indirectly, be reproduced, in whole or in part, adapted, modified, disclosed, transmitted, displayed, have derivative works prepared based upon them or otherwise be disseminated without the prior written consent of Masimo.

The information contained in this document is solely for use by the designated in-house representatives of current Masimo licensees who have agreed in writing to maintain the confidentiality of Masimo confidential information and not to use any of same other than as and to the extent necessary to use Masimo Corporation software on authorized hardware located at client's authorized facilities within the scope of the license granted to them by Masimo. Any other use by any other person or entity is strictly prohibited. Any violations of these requirements shall be reported to Masimo. This document must be returned to Masimo when the user is no longer licensed by Masimo to use Masimo software, and immediately upon Masimo's written request.

Masimo may make improvements or changes in the product(s) described in this document at any time. Masimo makes no representations or warranties regarding this document or the information contained herein and no information provided in this document modifies any warranties, disclaimers, limitations or other terms of any client's license agreement with Masimo. ALL IMPLIED WARRANTIES, INCLUDING, WITHOUT LIMITATION, IMPLIED WARRANTIES OF MERCHANTABILITY, FITNESS FOR A PARTICULAR PURPOSE, TITLE AND NONINFRINGEMENT, ARE HEREBY DISCLAIMED. Masimo shall have no liability for any errors or omissions contained in this document or otherwise relating to this document.

Authorized representative



EMERGO EUROPE
Prinsessegracht 20
2514 AP The Hague
The Netherlands



Contacts

Support contact information

Call Masimo Support at 1-833-274-4955, 24 hours a day, seven days a week.

You can also send an email to dcx-support@masimo.com. We monitor emails from 8:00 a.m. to 5:00 p.m. Central Time, Monday through Friday. Use email for non-emergencies only.

Manufacturer contact



Masimo Corporation
52 Discovery
Irvine, CA 92618, USA
Tel.: 949.297.7000
Fax.: 949.297.7001
www.masimo.com

About the Masimo iSirona

The Masimo iSirona™ is a connectivity solution that hosts Masimo DCX™ client software.

The iSirona lets you transmit patient data directly from medical devices to the DCX server and ultimately the patient's electronic medical record (EMR).

The iSirona performs the following functions:

- Connects up to six medical devices in a clinical setting, such as an operating room or intensive care environment, to improve efficiency at the point of care
- Continuously streams device data via battery backup while you transport patients within the hospital
- Provides system status using intuitive, easy-to-read icons
- Supports Power over Ethernet (PoE)
- Includes high-retention USB connectors (15 N) that prevent medical devices from accidentally disconnecting

Integration with your DCX server lets you view your list of iSironas and easily deploy necessary security updates at your convenience.

Note Masimo iSirona is compatible with DCX versions 05.16.000-0 and above.

Included in the Masimo iSirona kit

Item	Quantity
Masimo iSirona	1
Lithium-ion battery	1
Mounting bracket	1
AC/DC power supply	1
Insert with QR code to access user manual	1
Power cord	1

Masimo iSirona diagrams

Figure 1: Front view



A Screen that displays system status

Figure 2: Back view



A Battery door latch

B Power button

Figure 3: Bottom view

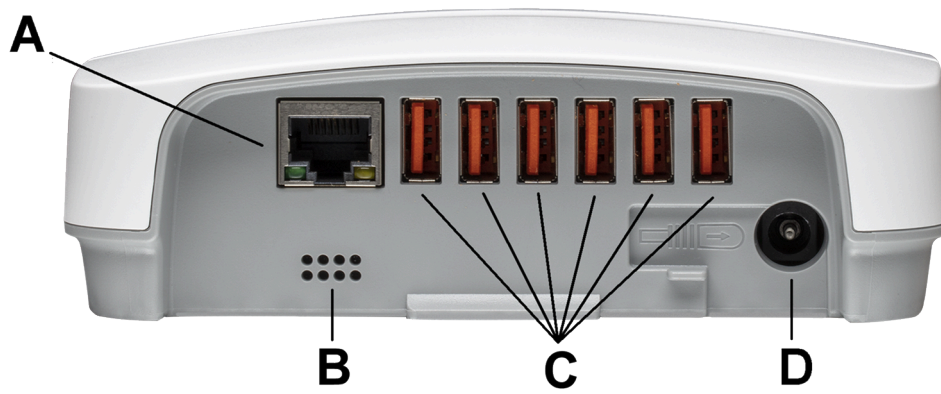

- A** Ethernet connector
- B** Speaker
- C** USB connectors
- D** DC power connection

Figure 4: Mounting bracket

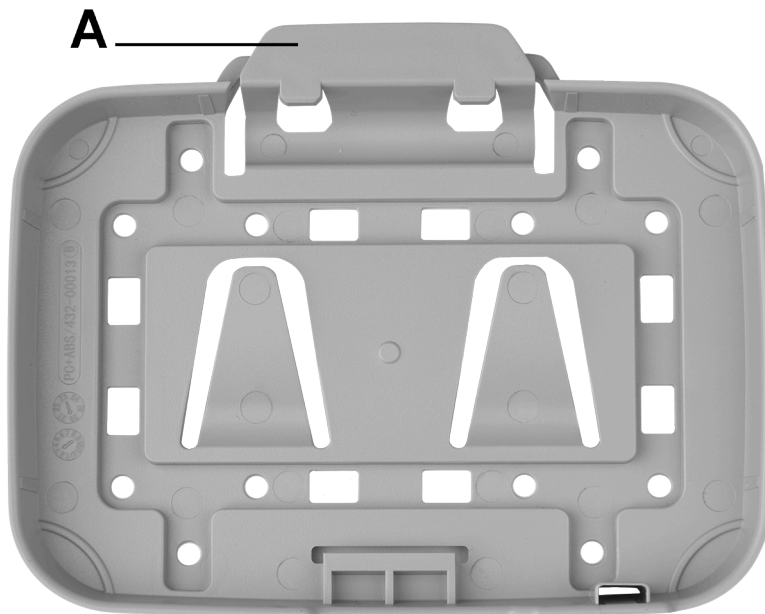

- A** Release tab

Masimo iSirona size and weight

Size

Item	Size
Masimo iSirona	139.5mm x 98.8mm x 47.2mm
Masimo iSirona with mounting bracket	140.5mm x 110.7mm x 53.0mm

Weight

Item	Weight
Masimo iSirona (with battery)	350g
Masimo iSirona (with battery and mounting bracket)	399g

Connectivity options

To transmit data, the Masimo iSirona supports Wi-Fi, Ethernet, and USB technology.

Wi-Fi

802.11 a/b/g/n connectivity

The iSirona supports connectivity to Wi-Fi using the following standards:

- 802.11a
- 802.11b
- 802.11g
- 802.11n

Security standards

When connecting to a Wi-Fi network, the iSirona uses the following security standards:

- WEP
- WPA
- WPA2

STA mode

The iSirona connects to a Wi-Fi access point on a local network that supports station computer (STA) mode.

Ethernet

The iSirona has one Ethernet port that supports speeds of 10/100/1000 mbps.

USB

The iSirona connects up to six USB devices.

- The iSirona is USB version 2.0 compliant.
- The iSirona USB connectors are type A female.
- USB connectors feature an extraction force of 15N to help prevent unintentional disconnects.

Install and remove the Masimo iSirona

Install the Masimo iSirona

The Masimo iSirona has a mounting bracket that lets it lie flat on a dry table or wall, or any hospital rail system with VESA mounts, such as an IV pole.

Always use the iSirona with the mounting bracket to prevent unintentional disconnection from the power supply, even if you mount it to a table.

Caution: Do not obstruct access to the AC power cord plug or Ethernet connector to ensure both are easily accessible after installation.

1. Insert the battery into the iSirona.
2. Identify a location for the iSirona on a flat surface.
3. Attach the mounting bracket to the surface using screws.
4. If you're using wall power, connect the output of the AC/DC power supply to the DC power connection on the bottom of the iSirona. You cannot insert the power cord after you insert the iSirona into the mounting bracket.
5. Insert the bottom of the iSirona into the bottom of the mounting bracket (the end opposite the release tab), and push the iSirona into the mounting bracket until the release tab clicks.

The iSirona is ready for use. You can connect the Ethernet cable, if using, as well as up to six devices using the Masimo Shuttle™ cables in the USB connectors.

The battery begins charging after you connect the iSirona to a power source.

Remove the Masimo iSirona from mounting bracket

Remove the Masimo iSirona from the mounting bracket to replace the battery, restart it, or turn it off.

To remove the iSirona from the mounting bracket, press the release tab with one hand while placing your other hand over the iSirona.

Mounting bracket configurations

The mounting bracket for the Masimo iSirona uses the following configurations:

- 75mm*75mm
- 50mm*50mm
- 100mm*50mm

Always use the iSirona with the mounting bracket to prevent unintentional disconnection from the power supply, even if you mount it to a table.

Battery maintenance

Charge the battery

The Masimo iSirona displays the battery charge level. The battery charge lasts about two hours if the iSirona is not connected to power.

If the iSirona's display indicates the battery power is low, plug the iSirona into wall power (or Power over Ethernet, if applicable) to charge the battery.

Replace the battery

Follow these steps to replace the Masimo iSirona battery.

Note *The iSirona battery should be replaced by trained personnel only.*

1. To remove the iSirona from the mounting bracket, press the release tab with one hand while placing your other hand over the iSirona.
2. Turn off the iSirona.
 - a. Press and hold the power button until **Confirm?** appears on the iSirona screen.
 - b. Release the power button when the confirmation question appears.
 - c. Quickly press and release the power button to confirm.
3. If attached, remove the output of the AC/DC power supply from the DC power connection on the bottom of the iSirona.
4. Press the release tab at the back of the iSirona to remove the battery door.
5. Disconnect the DC power connection cable from inside of the battery compartment on the back of the iSirona.
6. Remove the battery.
7. **Note** *Before connecting the new battery, remove the protective film on the thermal pad.*

Connect the new battery DC power connection cable to the inside of the battery compartment on the back of the iSirona unit.
8. Insert the new battery with the label facing down and the thermal pad facing up.
9. Replace the battery door to the back of the iSirona unit and press until the release latch clicks.
10. Connect the output of the AC/DC power supply to the DC power connection on the bottom of the iSirona, if desired.



Note *You cannot insert the power cord after you insert the iSirona into the mounting bracket.*

11. Press and hold the power button for five seconds to restart the iSirona.
12. Remount the device by inserting the bottom of the iSirona into the bottom of the mounting bracket (the end opposite the release tab). Push the iSirona into the mounting bracket until the release tab clicks.

Battery cautions



Do not disassemble, open, or service the battery.

	Use only a Masimo® authorized battery, or the warranty will be voided.
	Do not expose battery to a temperature above 70 °C or 158 °F.
	Do not crush, puncture, short circuit contacts, or dispose of in fire or water.

View the Masimo iSirona status





Icons on the Masimo iSirona show the following system status information:

- Wi-Fi signal
- DCX connection
- AC, battery, or Power over Ethernet







The vertical viewing angle is 80 degrees. The horizontal viewing angle is 112 degrees.

Wi-Fi signal

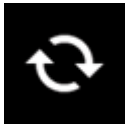





The Wi-Fi icon appears only if you configure the iSirona to use Wi-Fi.

Icon	Description
	<p>Wi-Fi is connected at full strength. Fewer bars mean lower signal strength.</p> <ul style="list-style-type: none"> • One bar RSSI  • Two bars RSSI  • Three bars RSSI  <p>Note The icon flashes as the iSirona connects to Wi-Fi.</p>
	No Wi-Fi connection
No icon	The iSirona is not configured to use Wi-Fi.

DCX connection

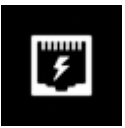
Icon	Description
	<p>DCX is connected.</p> <ul style="list-style-type: none"> • No animation: The DCX client is connected but DCX is in an idle state. • Spinning arrows: The DCX client is sending a heartbeat or device data to the DCX server. <p>Note The arrow animation blinks when viewing the status on a computer.</p>
	<p>DCX client is not operating.</p> <p>If the DCX client is not operating, remove the iSirona from the mounting bracket, and press and hold the power button for five seconds to restart it.</p>
	<p>The arrow animation moves downward when the DCX client receives a system profile or operating system update from the DCX server. The light color corresponds with the type of update.</p> <ul style="list-style-type: none"> • Green: Driver update  • White: OS update  • Blue: Node profile update 

AC, battery, or Power over Ethernet

Icon	Description
	<p>The iSirona is powering up.</p> <p>Note <i>The animation moves right and left when the iSirona is powering up.</i></p>
	<p>The iSirona is plugged into wall power only.</p> <p>No battery is installed.</p>
	<p>The iSirona is plugged into Power over Ethernet only.</p> <p>No battery is installed.</p>
	<p>The battery is in use.</p> <p>The iSirona is not plugged into wall power or Power over Ethernet. Fewer bars mean lower battery charge levels.</p> <ul style="list-style-type: none"> • No solid bars: 25% or less battery charge • One solid bar: 25%-50% battery charge • Two solid bars: 50%-75% battery charge • Three solid bars: 75% or greater battery charge <p>If the battery power is low, plug the iSirona into wall power (or Power over Ethernet, if applicable).</p>
	<p>The battery is charging.</p> <p>Note <i>The bars inside the battery icon blink when the iSirona is plugged into wall power or Power over Ethernet and the battery is charging.</i></p> <p>The number of blinking bars inside the battery icon represent the percentage of battery charge.</p> <ul style="list-style-type: none"> • One blinking bar: 25% or less battery charge • One solid bar and the second bar blinks: 25%-50% battery charge • Two solid bars and the third bar blinks: 50%-75% battery charge • Three solid bars and the fourth bar blinks: 75%-99% battery charge
	<p>The battery is fully charged and is plugged into wall power or Power over Ethernet.</p>

General handling instructions

General cleaning

The Masimo iSirona may be cleaned using common detergents and disinfection agents found in the hospital environment without degrading. Medical disinfectant wipes are recommended.

Ingress Protection (IP) rating

The iSirona has an IP rating of IP52.





Vertically dripping water has no harmful effect when the iSirona is tilted at an angle of up to 15° from its upright position.

Ingress of dust is not entirely preventable.

Environmental requirements

Keep the iSirona and the battery dry and away from sunlight.

The following table describes the environmental requirements.

Symbol	Parameter	Range low	Range high
	Operating Temperature	+5 °C	+40 °C
		+41 °F	+104 °F
	Atmospheric Pressure	700 hPa	1060 hPa
	Storage Temperature	-25 °C	+70 °C
		-13 °F	+158 °F
	Humidity (non-condensing)	5%	95%

Appendix

Electromagnetic emissions

Emissions Product Standards				
Standard	Test description	Test level/limits	Results	TUV SUD Report
EN 55011	Radiated Emissions	Class A	Pass	TP72157766.100
EN 55011	Conducted Emissions	Class A	Pass	TP72157766.200
EN61000-3-2/A1	Harmonic Current Emissions	Class A	N/A<75W	TP72157766.200
EN61000-3-3	Voltage Fluctuations and Flicker	$P_{st} \leq 1.0$ $P_{lt} \leq 0.65$ $d_c \leq 3.3\%$ $d_{max} \leq 4.0\%$	Pass	TP72157766.200

Immunity Standards (Non-Life Support)

TUV SUD Report

TUV SUD Report TP72157766.200

Immunity Standards (Non-Life Support)			
Standard	Test description	Test level/limits	Results
EN 61000-4-2	Electrostatic Discharge	2 kV, 4 kV (\pm) Contact Discharge 2 kV, 4 kV, and 8 kV (\pm) Air Discharge	Pass
EN 61000-4-3	Radio Frequency Electromagnetic Field Amplitude Modulated	80 MHz to 6000 MHz 3 V/m 80% AM 1 kHz	Pass
EN 61000-4-4	Electric Fast Transients	± 1.0 kV AC Power Port ± 0.5 kV Signal/Wired Network/Control Port	Pass
EN 61000-4-5	Surge	± 1 (Line to Line) ± 2 (Line to Earth) 5 surges/voltage/polarity @ 0°, 90°, 180°, and 270°	Pass

Immunity Standards (Non-Life Support)			
Standard	Test description	Test level/limits	Results
EN 61000-4-6	Radio Frequency Common Mode	0.150 MHz to 80 MHz 3 V rms 80% AM 1 kHz	Pass
EN 61000-4-11	Voltage Dips and Interruptions	70% of V nom 25 periods	Pass
		0% of V nom 1 period	
		0% of V nom 0.5 period	
		0% of V nom 250 periods	

